

**EVALUATION OF A HIGH SPEED, LIGHT LOAD
PHENOMENON IN TILTING-PAD THRUST BEARINGS**

by

Joseph J. Wilkes

Chief Engineer

Scan M. DeCamillo

Manager, Research and Development

Kingsbury, Inc.

Philadelphia, Pennsylvania

Mark J. Kuzdzal

Manager, Development Engineering

and

James D. Mordell

Bearing and Seal Engineer

Dresser-Rand Olean Operations

Olean, New York

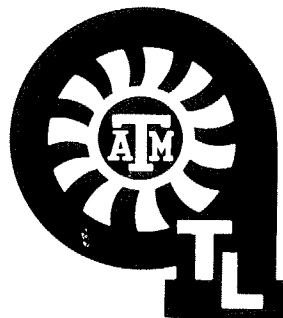

from

Proceedings of 29th Turbomachinery Symposium.

Copyright 2000. All rights reserved. Reprinted with permission of
the Turbomachinery Laboratory, Department of Mechanical Engineering,
Texas A&M University, College Station, Texas 77840-3123.

EVALUATION OF A HIGH SPEED, LIGHT LOAD PHENOMENON IN TILTING-PAD THRUST BEARINGS

by

Joseph J. Wilkes

Chief Engineer

Scan M. DeCamillo

Manager, Research and Development

Kingsbury, Inc.

Philadelphia, Pennsylvania

Mark J. Kuzdzal

Manager, Development Engineering

and

James D. Mordell

Bearing and Seal Engineer

Dresser-Rand Olean Operations

Olean, New York



Joseph J. Wilkes is the Chief Engineer at Kingsbury, Inc., in Philadelphia, Pennsylvania. He is currently responsible for overseeing all aspects of the engineering department, including bearing design, analysis, troubleshooting, research and development, and testing. Mr. Wilkes has traveled around the world to give technical presentations and troubleshoot bearing problems. He has one US patent and has two pending. Before coming to work at

Kingsbury in 1992, he worked 10 years at Philadelphia Gear where he was responsible for high speed gearbox design including rotordynamics, and designing gears, bearings, shafts, and housings.

Mr. Wilkes received his BSME from Villanova University (1991), and is a member of STLE.



Mark J. Kuzdzal is the Manager of Development Engineering at Dresser-Rand, Olean Operations, in Olean, New York. He has been employed there since 1988. Mr. Kuzdzal's areas of expertise focus on rotordynamics, bearing performance, and product/process development. He has coauthored four technical papers and holds one US patent.

Mr. Kuzdzal obtained a B.S. degree (Mechanical Engineering, 1988) from the

State University of New York at Buffalo.

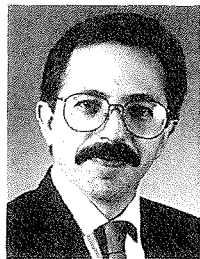

Scan M. DeCamillo is Manager of Research and Development for Kingsbury, Inc., in Philadelphia, Pennsylvania. He is responsible for design, testing, analysis, and development of fluid film bearings for worldwide industrial and military applications. He began in 1975 and has provided engineering support to industry regarding problem solving, design improvement, application, and operation of hydrodynamic bearings in various machinery.

During the course of his work, he has developed performance and structural tools for bearing analysis, established design criteria for power, naval, and nuclear applications, and has contributed information to ASM, AISI, EPRI, and API. He holds patents and is author of several technical papers. Current research is focused on improving the operation of hydrodynamic bearings in high-speed equipment.

Mr. DeCamillo received his B.S. degree (Mechanical Engineering) from Drexel University. He is a registered Professional Engineer in the State of Pennsylvania and a member of the Vibration Institute, ASM, ASME, and STLE.

ABSTRACT

This paper discusses a newly found high speed, light load hydrodynamic tilting-pad thrust bearing phenomenon. The phenomenon was first witnessed on centrifugal compressors operating above 10,000 rpm. Testing results have shown that in high speed, light load applications, thrust bearing babbitt temperatures are much higher than expected at low load conditions, and then drop to expected levels as the thrust load is further increased. This behavior has been observed in flooded and directed lube type bearings as well as center- and offset-pivot designs, occurring at sliding velocities above 300 feet per second (fps) at the mean pad diameter and at thrust unit loads between zero and 100 pounds per square inch (psi).

Additionally, the authors discuss the initial anomalies encountered at an original equipment manufacturer's testing facility; extensive testing at the bearing manufacturer's facility to first reproduce the bearing behavior and then to introduce geometry modification to address the phenomenon. Finally, successful low load testing as well as high load testing is presented with the enhanced thrust bearing design.

INTRODUCTION

Common sense, "rules of thumb," and generalizations are useful in understanding bearing performance until you must explain why tilting-pad thrust temperatures would decrease with increasing thrust load.

As in any industry, there is a continual push to improve products. In the world of turbomachinery, directed lubrication has many

advantages over traditional flooded bearing designs. As a result, the end users often ask the turbomachinery original equipment manufacturer (OEM) to include a directed lube thrust bearing as a product offering. It has been the goal of bearing designers to decrease oil flowrate and horsepower (hp) consumption without increasing pad temperatures within the bearing. Bearing manufacturers conduct numerous tests and present data to show the industry the relative improvements of a directed lubrication bearing with respect to a flooded bearing. The tests are conducted at high loads and speeds because that is normally where high temperatures limit the application.

Typically, a centrifugal compressor must pass a low-pressure API mechanical spin test before it is shipped to the site. This test looks for, among other things, bearing performance as measured in oil flowrate and temperatures. Typically, a low-pressure test produces light loads on the thrust bearing. These light loads are expected to result in low pad temperatures. In recent test experiences, higher than expected acceptance test temperatures were encountered with directed lube thrust bearings, which has caused delays.

The problem was first identified on a centrifugal compressor on the OEMs test stand in March 1998. The compressor unit's thrust bearing configuration was a 10.5 inch leading edge groove (LEG), and was operating at approximately 400 fps mean sliding velocity with light axial load. The test failed due to pad temperatures in excess of 240°F and a drain temperature that exceeded 200°F.

Immediately following the OEMs March test failure, at least a dozen high risk contracts were identified. These contracts were approaching the test phase in the OEMs facility. Each consisted of compressors containing thrust bearings, which would run at speeds where the phenomenon was experienced. The importance to find a solution became critical.

The behavior has been observed in center- and offset-pivot bearings, occurring at sliding velocity above 300 fps at the mean pad diameter and thrust loads between zero and 100 psi. However, at these higher speeds, directed lube bearings are almost exclusively used.

Another observation has been that the bearing, which is orificed on the supply side, passed the prescribed amount of oil at slow rotational speeds. But as the rotational speed increases, the flowrate to the bearing is not constant. As a matter of fact, the faster the bearing runs the less flow the bearing would accept. Hence, at full speed and light load, the bearing performance is unsatisfactory with respect to the low-pressure API mechanical spin test temperature criteria.

Regardless of the measures taken, the flow versus speed dependency could not be overcome. The result was failed tests and loss of client confidence. The bearing manufacturer has tested his design at much higher loads with acceptable results while low load compressor testing yielded unacceptable results. This fact was perplexing and spawned an extensive low load thrust bearing testing program at the bearing manufacturer's facility.

This paper discusses a hydrodynamic tilting-pad thrust bearing temperature phenomenon that occurs at high speeds and at low thrust loads. Further, it discusses a testing program held at the bearing manufacturer's site, which was successful at reproducing the behavior and solving the problem. Finally, successful low load testing as well as high load testing is presented with the enhanced thrust bearing design. To the best that the authors could determine, this problem has not been reported in prior literature.

TEST OVERVIEW

In May of 1998, a testing program was started at the bearing manufacturer's facility to investigate the cause of the higher than normal temperatures and reduction of oil flowrate on LEG thrust bearings operating at high speed and light loads. The testing was initiated largely by a request from the compressor OEM who was experiencing the bulk of the problems, and also due to problems

experienced with other turbomachinery manufacturers. The testing took about eight months to complete, during which time the reason for the high speed, light load phenomenon was discovered.

The test plan was to model the bearing manufacturer's inhouse test rig with similar bearings and configuration and then run them under conditions that matched those where the problems were experienced. Once the problem could be duplicated on the test rig, experiments and modifications could be tried to find the source of the problem.

TEST EQUIPMENT

A variable speed gas turbine with a rated output of 1100 hp and a controllable test speed range from 4000 to 14,000 rpm is the prime mover. The turbine is connected to the test shaft by means of a flexible coupling. Two identical housings external to the turbine enclosure contain the bearing components (Figure 1). The forward housing adjacent to the turbine is firmly secured to the foundation, while the aft housing is restrained, but is free to slide axially. Each housing contains a horizontally mounted double element thrust bearing and a tilting-pad journal bearing to radially support the test shaft. Each housing is also equipped with separate lubricant supply and drain lines.

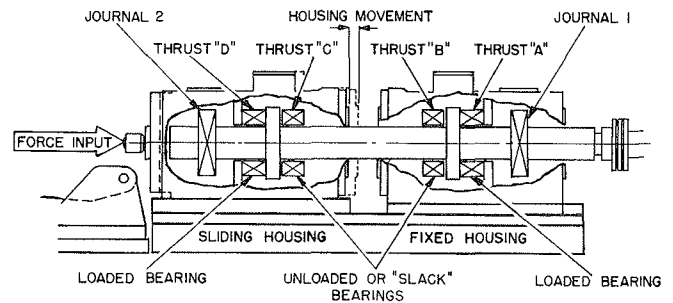

Figure 1. Bearing Arrangement Within Test Housings.

Axial load is applied by means of an external hydraulic system that transmits force directly to the sliding housing. As a result of the single applied force, both thrust bearing "A" and "D" experience the same loading, while thrust bearings "B" and "C" remain unloaded. A load cell is mounted on the end of the sliding housing for the purpose of measuring the total applied thrust load.

The thrust bearings in the sliding housing are six-shoe design and the thrust bearings in the fixed housing are eight-shoe design. All thrust bearing shoes have a babbitt outside diameter of 10.5 inches, a bore of 5.25 inches, and a total bearing area of 55.1 square inches (sq in).

Small thermocouples are imbedded in the babbitt metal of each thrust bearing pad. The actual thermocouple junction is positioned within .03 inch of the babbitt surface. All shoes have a thermocouple at the 75/75 location. This is an industry standard location and is defined as the location on the shoe face that is 75 percent of the distance from the leading edge and 75 percent of the distance from the inside shoe radius outward. The maximum 75/75 temperatures used in this paper represent the hottest shoe out of all shoes in that bearing. Also, an array of 10 thermocouples is installed in one pad of each of the loaded bearings, "A" and "D," in order to determine the temperature gradient in both the radial and circumferential directions.

TEST PROCEDURE

During the testing program, many variations of bearing geometry were tried in an effort to solve the problem at hand. This paper reports only the small amount of data that was significant to solving and understanding the problem.

For all the tests described in this paper, the fixed housing contained an eight-shoe LEG double element thrust bearing (Figure 2). This bearing is described by Mikula and Gregory (1983), and additionally by Mikula (1985) and Mikula (1987). These papers include much performance test data, but do not uncover the phenomenon talked about here.

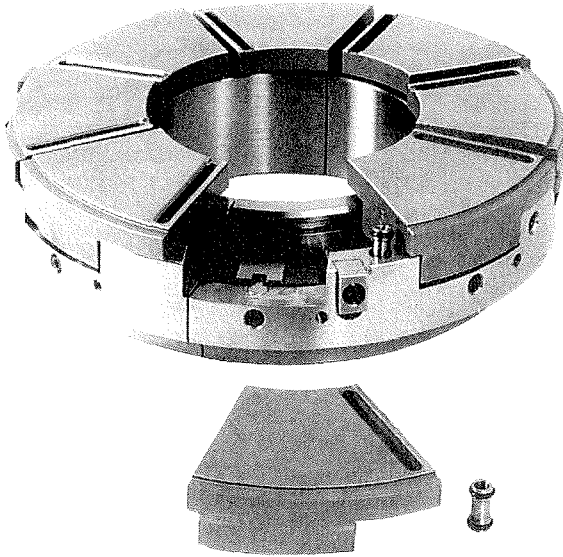

Figure 2. Test LEG Thrust Bearing.

Referring to Figure 2, the oil is supplied to this bearing by way of an annulus machined at the back of the bearing. From there, the oil passes through feed tubes that connect the annulus to grooves in each shoe. The grooves, on the leading edge of each shoe, supply oil directly into the hydrodynamic wedge. During the testing, the same LEG bearing shoes were used throughout, but were modified a number of times for purposes of the test.

The sliding housing contained six-shoe, flooded type, double thrust bearings. The active six-shoe bearing pads were changed during the tests to different offset-pivot configurations, as well as being modified, but the shoe surface maintained the same area and shape.

Because the problem occurred only at light loads, special attention was paid to the load zone of between zero and 100 psi unit load. Extra load cells were installed under each shoe in the sliding housing in order to accurately apply load. Thrust loads in 10 to 25 psi increments were applied between zero and 200 psi unit load. 100 psi increments were then used between 200 and 500 psi.

Speeds of 4000 to 14,000 rpm were run with 1000 rpm increments. In some cases at the highest speeds, difficulties with oil flowrates limited the ability to obtain data. Data presented are also limited due to space and the clarity of the plots and graphs.

In most cases, the lubricant flowrates to the LEG bearing were changed with each speed but remained constant for the load range at a given speed. This was done in order to isolate the effect of load on the film temperatures and supply pressures. For the flooded bearing, the flowrate varied for each speed and for each load. This was done in order to be consistent with tests performed previously at the bearing manufacturer's facility. Throughout the test, ISO VG32 lubricant at an inlet temperature of 120°F was used.

In a typical test series, the shaft speed would be set constant and then the required load would be applied, usually starting at zero and then working up through the load range to 500 psi unit load. At each point, the speed and load are held until all the temperatures stabilized at which point the data were recorded. In a given test, data at 18 load points and at 11 different speeds were collected.

TEST RESULTS

Reproducing the Problem on the Test Rig

The first test series was run with standard LEG thrust bearings in the fixed housing and standard center-pivot flooded bearings in the sliding housing. The initial task was to duplicate the problem on the test rig as it occurred on the compressor manufacturer's test stand.

Figure 3 displays the maximum 75/75 pad temperatures for the standard LEG thrust bearing for various loads and speeds. Of interest is the pronounced increase in temperature at 10,000 rpm at approximately 40 psi unit load. This sudden increase in temperature is similar to what has been experienced on the compressor manufacturer's test stand. This is unexpected due to the temperatures rising to a peak at 40 psi and then falling as the load is increased to 100 psi. Above 100 psi the temperatures continue to steadily rise in an expected fashion. This phenomenon is somewhat apparent at 8000 rpm and may be less apparent at 12,000 rpm. The 4000 rpm and 6000 rpm tests exhibit a more expected increase in temperature with load.

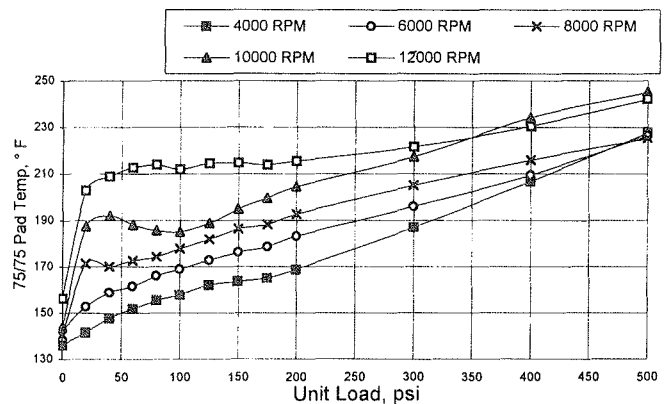

Figure 3. Standard LEG Maximum 75/75 Pad Temperatures at Recommended Flowrates.

Figure 4 displays data for a 60 percent offset-pivot, flooded bearing, installed in the sliding housing. The data display unusual increases in temperature at low loads and then decreasing temperatures as the load is increased to approximately 200 psi. In both these figures (Figures 3 and 4), the 75/75 temperatures respond to what would be considered normal between 200 and 500 psi. It is apparent from these graphs that this phenomenon exists with flooded type bearings as well as LEG type bearings.

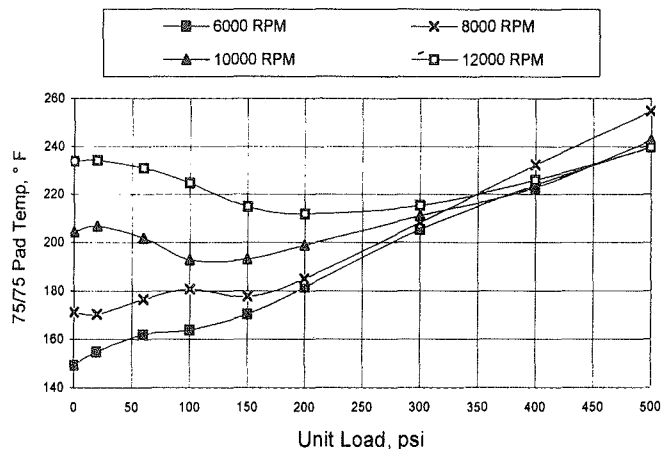

Figure 4. Flooded, 60 Percent Offset-Pivot, Maximum 75/75 Pad Temperatures.

Oil Supply Pressures

Flooded designed thrust bearing oil supply pressure requirements are typically very low, on the order of zero to 5 psig, and the flowrate is normally controlled using an orifice. These pressures are low due to the fact that the bearing oil passageways in a flooded design are relatively large and offer little resistance to the oil flow. In directed lube bearings and LEG bearings, the oil supply pressure requirements are typically higher, on the order of between five and 30 psig. With LEG bearings the oil is supplied directly into the oil film at the leading edge of the pad and, therefore, the oil film conditions can affect the supply pressure requirements.

Figure 5 displays the inlet pressure required to supply the test flowrates to the standard LEG bearing. Figure 6 (oil flow) displays the flowrates. The inlet pressure was adjusted to maintain the test flowrates. The flowrate was held constant across the load range for a particular speed. These data display a large increase in pressure requirement between zero and 100 psi unit load. Above 100 psi (200 rpm for 12,000 rpm), the pressure drops to normal expected levels. These data also show that the effect is only present at speeds of 8000 rpm (275 fps) and higher, and suggests that there is a transition point in the speed range at which the phenomenon occurs.

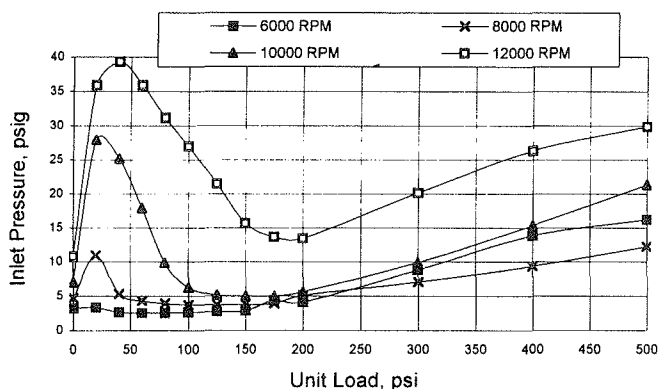

Figure 5. Standard LEG Oil Supply Pressure for Recommended Flowrate.

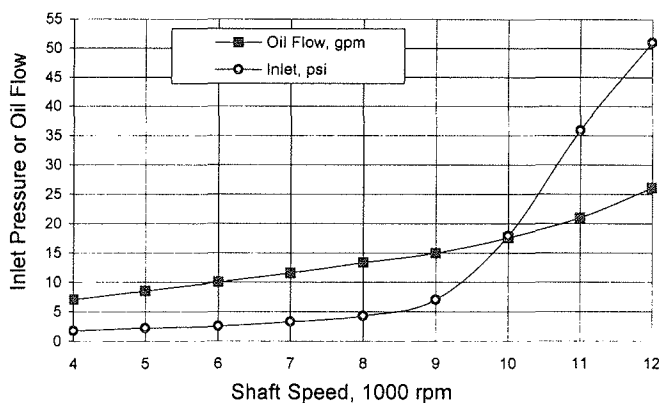

Figure 6. Standard LEG Oil Supply Pressure and Recommended Flowrate Versus Speed at 60 PSI Unit Load.

The oil supply pressures for the flooded design bearings were unaffected by this phenomenon at high speed and light loads due to the fact that the oil is not fed directly into the film. In a flooded thrust bearing design, supply oil is passed between the shoes and so the external oil pressure requirements do not change. Likewise, in spray designs, the supply pressure would not be affected; however, temperature increases in the higher speed zones still occur as indicated in Figure 3. The LEG offered additional insights into the problem because of its direct connection of oil into the film.

Fixed Valve Test

At this point it was apparent that the behavior experienced at the compressor manufacturer's facility could be reproduced. Of course, in the field, the supply pressure or the orifice would not typically be adjusted to maintain the flow. Most machines are designed with an orifice sized to control the oil flowrate at the bearing's rated load and for the machine's maximum continuous speed.

Data in Figure 6 display the supply pressure and recommended flow plotted against speed for 60 psi unit load case. This plot is typical of what an OEM would see when running a machine up to speed on a test stand under a light load condition. Data show a tremendous rise in required oil supply pressure as the speed increases above 9000 rpm (309 fps). These data matched well with the information received from the OEM who experienced that the flow would decrease as the speed increased. With a fixed orifice or a fixed supply pressure, it is obvious that the flowrate will decrease with increasing speed. To better simulate what the OEM was experiencing on test, a fixed valve test was conducted. This test was accomplished by setting the flowrate to the desired level for 10,000 rpm and 500 psi load. Then, during this test for all speeds and all loads, the inlet valve was not adjusted, as to simulate an orifice.

Figure 7 displays pressure and flow data for this test at 50 psi unit load plotted against speed. It can be seen that the flowrate remains steady up to 8000 rpm (275 fps) and then slowly drops as the speed further increases. While the flow drop is not seemingly significant, it must be remembered that the flowrate should be increasing with speed as in Figure 6. The flowrate at 12,000 rpm is almost half the recommended value. Figure 7 also shows that the pressure, while fairly stable up to about 9000 rpm (310 fps), increases to double its initial value. This test better simulates what OEMs and end users typically do on test stands and in the field.

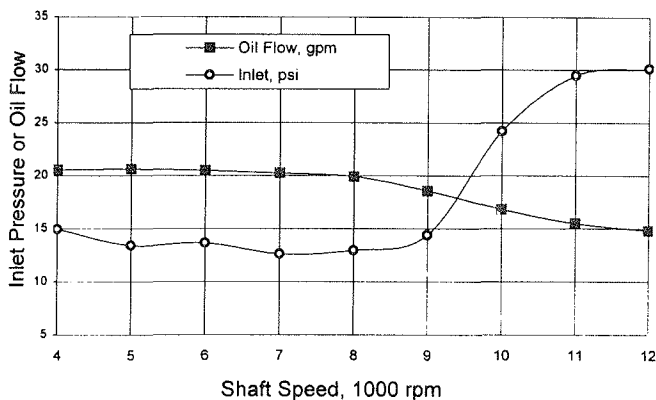

Figure 7. Standard LEG Oil Supply Pressure and Flowrate Versus Shaft Speed for Fixed Valve Test at 50 PSI Unit Load.

Figure 8 displays the maximum 75/75 pad temperatures for this fixed valve test. The temperature increases are more pronounced than in Figure 3. The reason for this is that the oil flowrate is reduced as shown in Figure 7.

Figure 9 displays the supply pressure for the fixed valve test plotted against load for three different speeds. These data show that at 4000 rpm it takes more and more pressure to supply the oil as the load is increased. This would be considered to be a normal relationship between supply pressure and unit load for a LEG thrust bearing. These data also show that at high speeds and light loads, such as the case of 12,000 rpm, the pressure requirement is increased dramatically from zero to 50 psi, but then falls steadily as the load increases. This fluctuation in supply pressure highly emphasizes the phenomenon.

Fixed Pressure Tests

Oftentimes on OEM test stands the oil supply pressure is held constant during the test. It was decided to run a test in which the

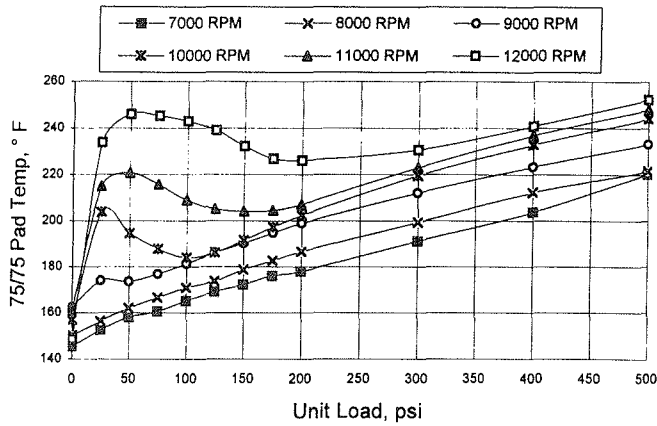

Figure 8. Standard LEG Maximum 75/75 Pad Temperatures for Fixed Valve Test.

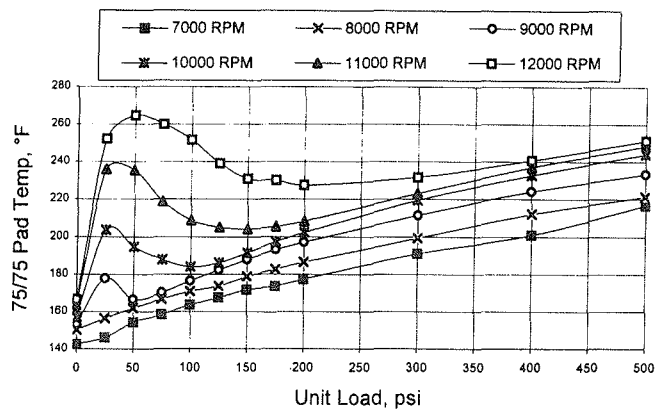

Figure 11. Standard LEG Maximum 75/75 Pad Temperature for Fixed Pressure Test.

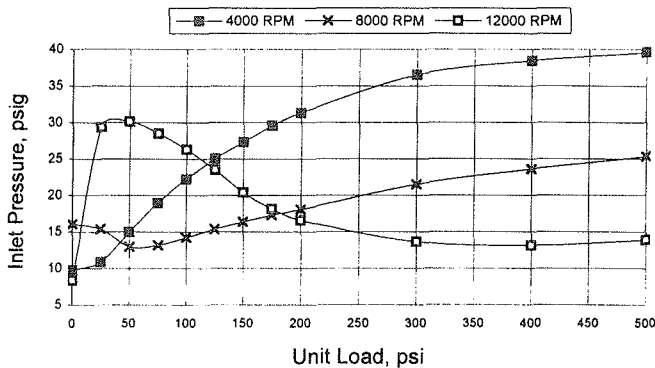

Figure 9. Standard LEG Oil Supply Pressure for Fixed Valve Test.

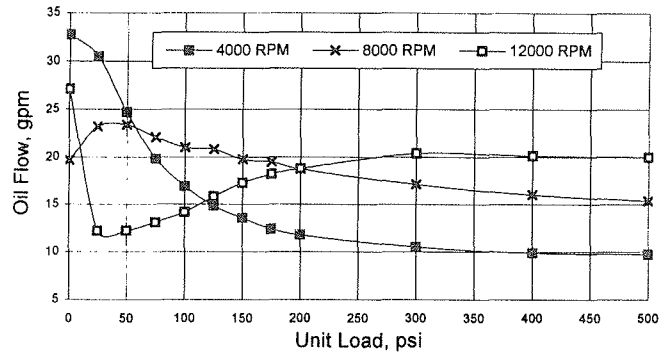

Figure 12. Standard LEG Oil Flowrate for Fixed Pressure Test.

supply pressure was held constant for each speed and each load. The supply pressure selected was 20 psig, and would be maintained throughout by adjusting the inlet valve.

Figure 10 displays the oil flowrate for that test plotted against speed for 50 psi unit load. The data show a fairly steady flowrate up to a speed of 9000 rpm (310 fps) and then it decreases to approximately half its original value as the speed further increases. This behavior again matches the OEMs experience.

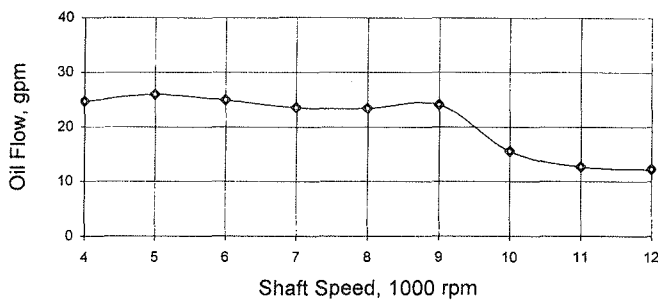

Figure 10. Standard LEG Oil Flowrate Versus Speed for Fixed Pressure Test at 50 PSI Unit Load.

Figure 11 displays the maximum 75/75 pad temperature for this fixed supply pressure test. These data reflect the spike in temperature at high speed and light loads. Again these data show a transitional speed above 8000 rpm (275 fps) at which this phenomenon occurs.

Figure 12 displays the oil flowrates for the fixed supply pressure test plotted against load for three different speeds. This figure displays the unexpected reaction of oil flowrate at high speed and light loads.

Figure 13 displays maximum 75/75 pad temperatures for three different flooded bearing designs at 12,000 rpm: a center-pivot bearing, 60 percent offset-pivot bearing, and a 68 percent offset-pivot bearing. These data show that while the offset-pivot bearings ran cooler than center-pivot, they all exhibited the phenomenon.

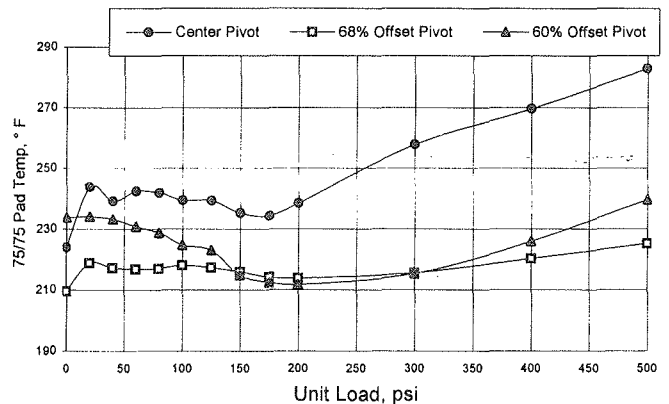

Figure 13. Maximum 75/75 Pad Temperatures for Different Flooded Bearing Designs at 12,000 RPM.

In summary, it is believed that a good working model of the problem has been established. Figure 14 displays maximum 75/75 temperatures for: the catalog flow test, fixed valve test, and fixed pressure test at 12,000 rpm. The catalog flow data do not look that unusual; however, it must be recalled that the oil was forced into the bearing at unusually high pressures (Figure 5). Similar results were obtained from tests with chrome copper backed LEG bearings.

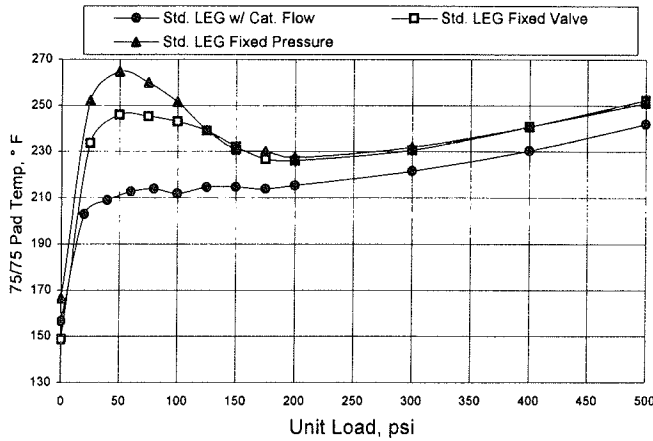

Figure 14. Standard LEG Maximum 75/75 Temperatures at 12,000 RPM for: Recommended Flowrate, Fixed Valve, and Fixed Pressure Tests.

ANALYSIS OF THE PROBLEM

Finding the Solution

The known information was analyzed and it was concluded that the main problem was the reduction in oil flowrate with increasing speed. In the past, the OEM had removed the oil feed tubes, which connect the oil supply directly to the oil film wedge. Removing the feed tubes broke the relationship between speed and oil flowrate; however, the oil film temperatures were still high. LEG tests conducted at the bearing manufacturer's facility without the feed tubes yielded similar results as the OEM experienced. It was concluded that this was not a LEG specific problem as the data show (Figure 13) but a hydrodynamic oil film phenomenon and therefore modifications made strictly to the LEG feature would not solve the problem.

In reviewing the data for the fixed valve test, it was noticed that at 12,000 rpm, the 75/75 temperature at 50 psi unit load was about the same as the temperature at 500 psi (Figure 8) and so isotherms were plotted for these conditions (Figures 15 and 16). The isotherms at 500 psi (Figure 15) are normal and expected in a typical hydrodynamic thrust bearing. However, reviewing the isotherms at 50 psi (Figure 16), it is very apparent that the leading edge temperatures are excessive. Note that in both isotherms, the 75/75 temperatures are the same for 50 and 500 psi.

AB41 12000. RPM, 500. PSI, 50. PCT, T75/75 = 245. F, TMAX = 282. F

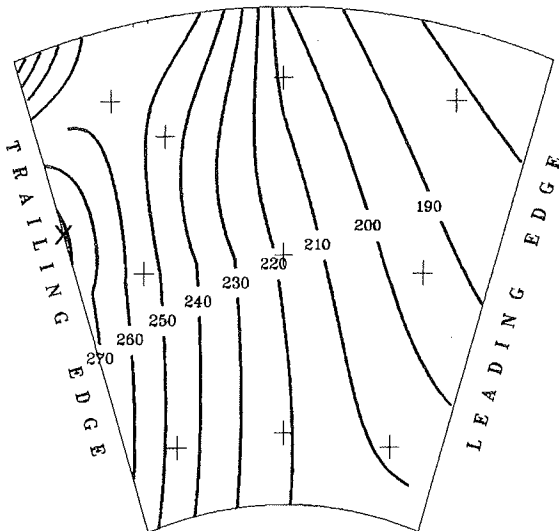

Figure 15. Isotherm of Standard LEG Shoe for Fixed Valve Test at 500 PSI Unit Load and 12,000 RPM.

AB41 12000. RPM, 50. PSI, 50. PCT, T75/75 = 245. F, TMAX = 252. F

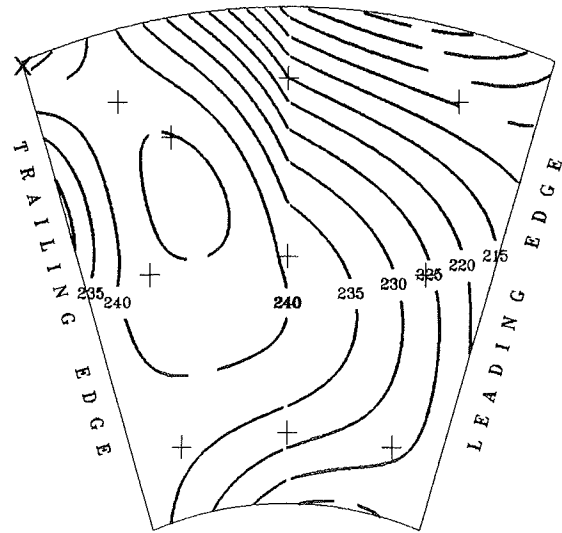

Figure 16. Isotherm of Standard LEG Shoe for Fixed Valve Test at 50 PSI Unit Load and 12,000 RPM.

Considering the results of the test so far, and the fact that the leading edge of the pad is running much hotter than it should be, it was theorized that the tilt of the shoe and thus, the leading edge film thickness was being reduced. If this were the case, the leading edge groove that supplies oil to the film, would be closed off or restricted, and this would certainly lead to high oil film temperatures, reduced flowrates, and increased supply pressure requirements.

It was theorized that the shoes were operating with almost no tilt or parallel to the rotating collar. This small tilt reduces side leakage and the quantity of oil that can enter the oil film region. Oil can only be forced into the bearing with high supply pressures. Also, with a reduced shoe tilt, the effectiveness of the hydrodynamic action is reduced, which leads to a reduced oil film thickness and this causes high oil film temperatures.

Shoe Moments and Forces

If the moment caused by viscous drag on the shoe surface is larger than the counter moments being in the oil film region, then reduced shoe tilt may occur. Referring to Figure 17, the friction force from the film shear (F) causes a counterclockwise moment on the pad whereas the hydrodynamic pressure profile from load gives a clockwise moment. Under normal load, the hydrodynamic pressures are high, as compared with the frictional force, and the shoes operate per hydrodynamic theory. However, under light loads at high speeds, this becomes reversed. The high speed creates a large viscous drag on the shoe surface and with light loads the oil film pressures are small. This leads to the moments becoming dominated by the friction force from the film shear, which tends to close the leading edge. As speed increases, so does the viscous drag, which leads to higher required thrust loads for normal operation. This fits the trend of the data (Figures 8 and 11) that shows that at higher speeds, the so-called "light load" becomes higher. At 10,000 rpm the high temperature behavior occurs below 100 psi, where at 12,000 rpm the behavior occurs below 200 psi.

A method is needed to increase the shoe tilt so that the leading edge gap is greater than the trailing edge gap in all conditions of operation. One way to accomplish this is by having a device or method that would provide additional oil film pressure on the leading edge of the pad to counteract the frictional force. The magnitude of the frictional force can be calculated from the test power loss. Knowing the shoe thickness (which is the moment arm), the moment on the pad can be calculated. This allows a designer to calculate the required counteracting force to maintain proper shoe tilt at low thrust loads.

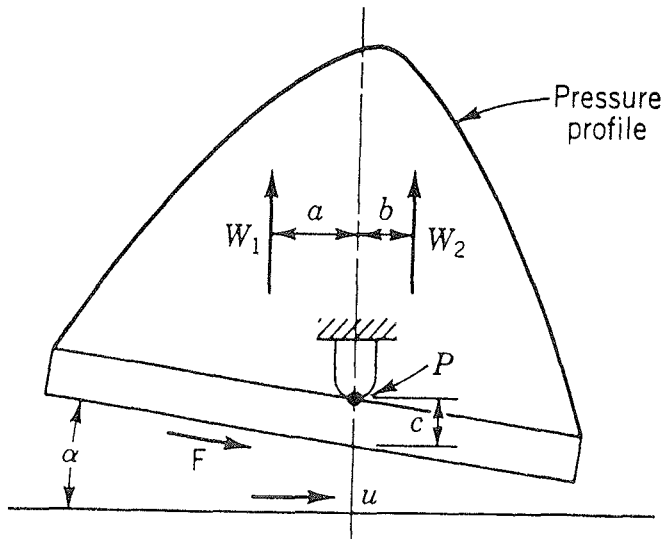

Figure 17 Hydrodynamic Pressures and Forces on a Tilting-Pad Thrust Shoe.

The Modification

The method that was found to accomplish the goal is a tapered region on the leading edge of the shoe, just downstream of the leading edge groove, as shown in Figure 18. Like a tapered land thrust plate, this tapered region creates hydrodynamic film pressure on the leading edge of the shoe, which creates a moment opposite to the friction moment. The smaller the leading edge gap the larger the effect of the taper. Also, the tapered region dimensions can be varied at the design stage for different applications based on predicted power loss. Once a higher thrust load is applied, the oil film pressure moment becomes dominant and the bearing operates as it normally would.

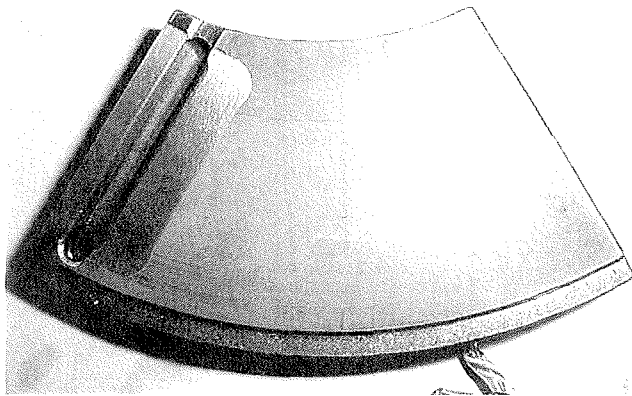

Figure 18. Tapered Modification on the Leading Edge of the LEG Shoe.

TEST RESULTS OF THE MODIFIED LEG

Figure 19 displays the maximum 75/75 pad temperatures for the modified LEG for various speeds across the load range. From these results it can be seen that the taper modification had a positive effect on pad temperatures. Figure 20 compares the supply pressure for the modified LEG and unmodified LEG. It can be seen that the taper modification had a pronounced effect on the oil supply pressure requirements.

The taper modification was also applied to the leading edge of a 68 percent offset-pivot, flooded bearing. Figure 21 displays 75/75

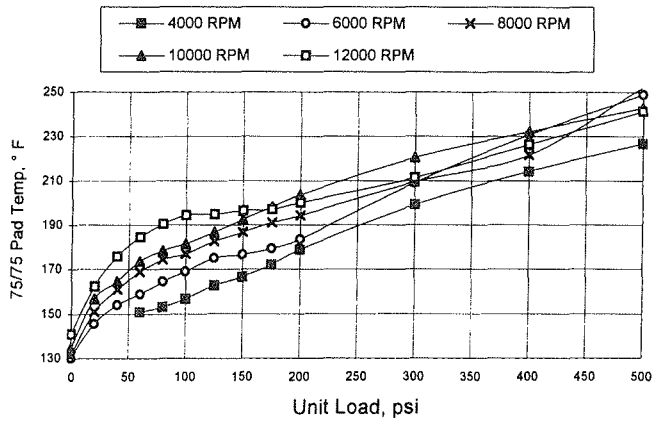

Figure 19. Maximum 75/75 Pad Temperatures for the Modified LEG at Recommended Flowrates.

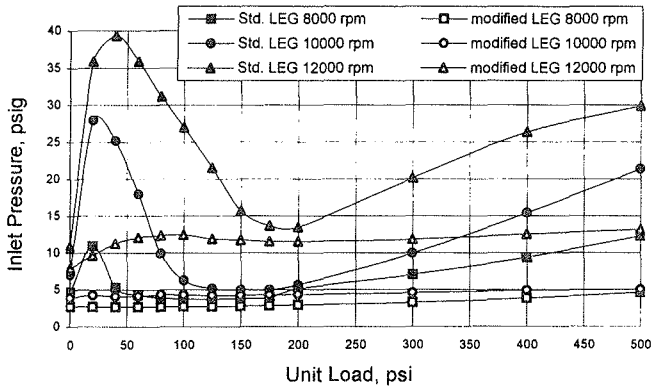

Figure 20. Oil Supply Pressure for the Modified LEG and Standard LEG for Recommended Flowrate.

pad temperature versus load for the modified and unmodified 68 percent offset bearings. It can be seen that the taper modification had a positive effect on the flooded bearings as well.

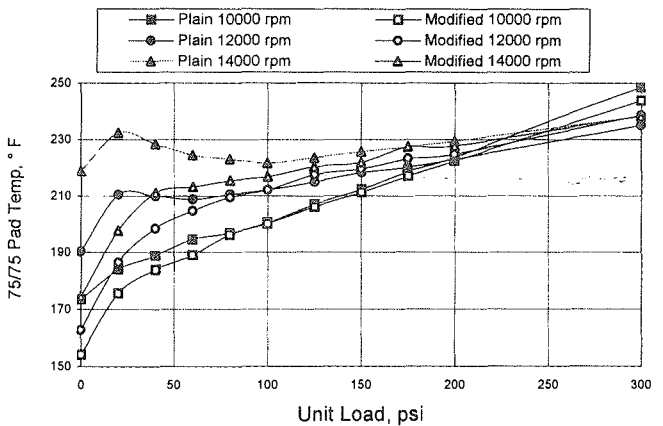

Figure 21. Maximum 75/75 Pad Temperature for the Modified and Unmodified 68 Percent Offset-Pivot Flooded Bearings.

A test was performed with the modified LEG bearing with a fixed valve configuration similar to what was done prior with the unmodified LEG (Figure 7). This test was accomplished by fixing the valve position to obtain a desired flowrate at a set speed and load. The valve position was fixed for the remainder of the test. Figure 22 plots the flowrate for the modified and the unmodified LEG. It can be seen that the modified LEGs flowrate is almost constant across the speed range.

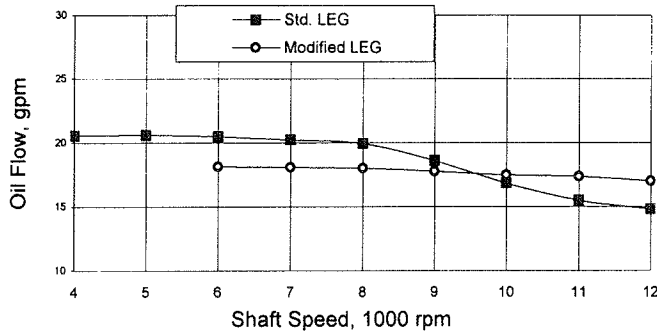

Figure 22. Oil Flowrate Versus Speed at 50 PSI Unit Load for Fixed Valve Test for the Modified LEG and Standard LEG.

Figure 23 is the fixed valve test data of the supply pressure versus speed for the modified and unmodified LEG at 50 psi unit load. Again, it can be seen that the supply pressure is almost constant.

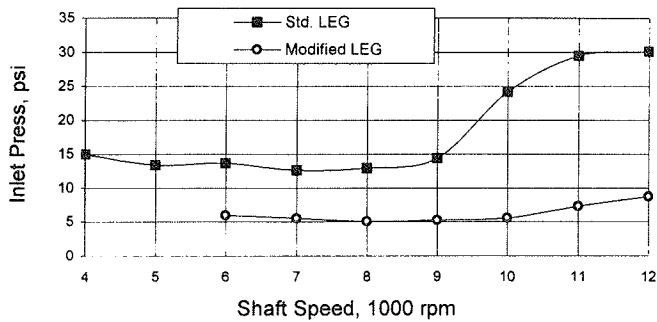

Figure 23. Oil Supply Pressure Versus Speed at 50 PSI Unit Load for Fixed Valve Test for the Modified LEG and Standard LEG.

Summary of the Tests

Figure 24 displays maximum 75/75 temperatures versus load for the taper modified LEG, the standard unmodified LEG with recommended catalog flowrates, the unmodified LEG fixed valve, and the unmodified LEG fixed supply pressure test at 12,000 rpm. From these data it can clearly be seen that the taper modification effectively addresses the phenomenon.

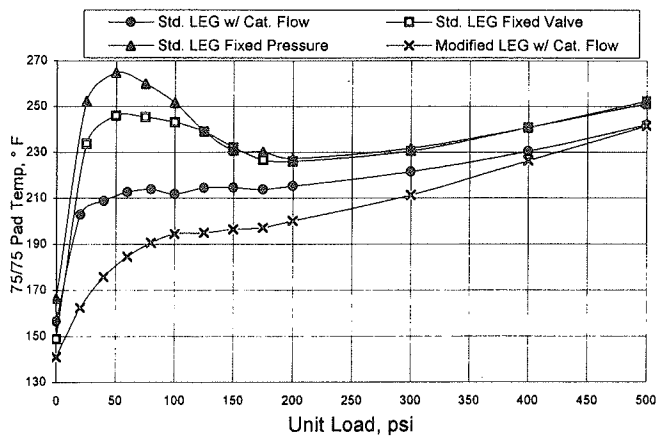

Figure 24. Maximum 75/75 Pad Temperatures at 12,000 RPM for the Modified LEG with Recommended Flowrates, the Standard LEG with Recommended Flowrates, the Standard LEG Fixed Valve, and the Standard LEG Fixed Pressure Tests.

Figure 25 is an isotherm of the tapered modification pad for comparison with Figure 16, under the same fixed valve conditions

at 50 psi load. This isotherm shows that the temperatures are normal and that the taper successfully opened the leading edge, hence allowing cool oil to enter as evident of cooler temperatures at the leading edge. At 500 psi (Figure 26 versus Figure 15), the modified and unmodified bearings are very similar.

AB71 12000. RPM, 50. PSI, 50. PCT, T75/75 = 198. F, TMAX = 227. F

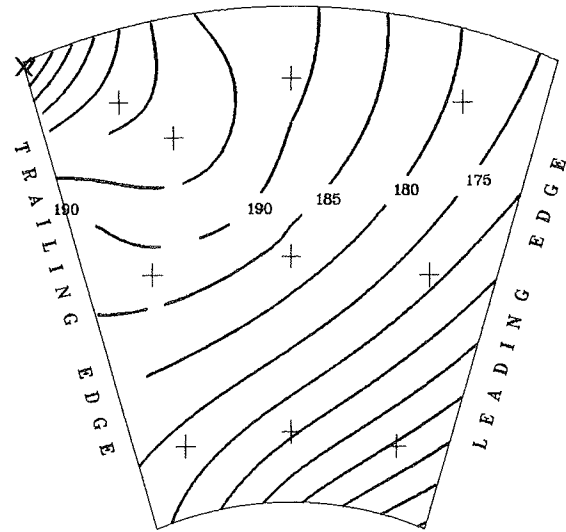

Figure 25. Isotherm of Modified LEG Shoe for Fixed Valve Test at 50 PSI Unit Load and 12,000 RPM.

AD10 12000. RPM, 500. PSI, 50. PCT, T75/75 = 238. F, TMAX = 259. F

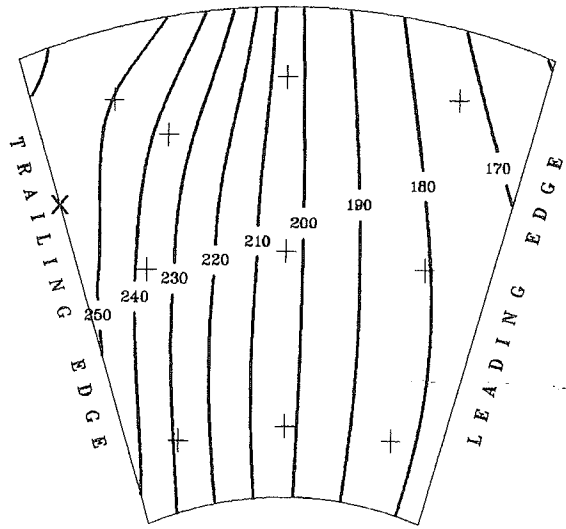

Figure 26. Isotherm of Modified LEG Shoe for Fixed Valve Test at 500 PSI Unit Load and 12,000 RPM.

Incorporating the taper raised a concern that it would change the effective pivot offset or reduce the pad area, thus increasing the pad temperatures at high load. Comparing Figures 26 and 15 and reviewing Figure 24, the data display that the taper proved beneficial through all load ranges. The reason for this can be subject to speculation. It may be that the taper continues to provide beneficial forces at the higher load operating conditions.

CONCLUSIONS

A testing program was conducted in order to determine the cause of the higher than normal temperatures and reduction of oil

flowrate on leading edge groove (LEG) thrust bearings operating at high speed and light loads. Using the bearing manufacturer's test rig, the problem was duplicated and the reason for the behavior was discovered. Modifications to the bearings led to a solution that successfully eliminates the undesirable effects of this newly documented phenomenon. The following conclusions have been formulated through the testing program:

- The effect of this phenomenon yields higher than expected pad temperatures at light loads. As the load increases, the pad temperatures return to expected values. Additionally, with LEG type bearings, the oil pressure required to supply the recommended flowrate becomes very high.
- The phenomenon is observed in all types of hydrodynamic tilting-pad thrust bearings including flooded, directed lube, center-and offset-pivot, steel, and chrome copper backed bearings.
- The phenomenon occurs at mean sliding velocities above 300 fps and at light thrust loads. The actual load at which it occurs depends on the speed, but typically is in the range of zero to 100 psi unit load.
- The phenomenon is believed to occur when the moment due to viscous drag on the shoe surface exceeds the moment from the hydrodynamic oil film force. Viscous drag increases with speed and its moment can exceed the film force moment under light load conditions.
- A taper modification has proven to effectively address the phenomenon in directed lube and flooded designs by exerting additional hydrodynamic force at the leading edge. This additional force maintains the proper tilt of the shoe and keeps the leading edge gap open. Tests show that pad temperatures are reduced by as much as 80°F and oil supply pressures lowered by as much as 25 psi.

- The taper modification has been successfully applied at light loads in the OEM facility and at high loads in the field. The OEM reported that a handful of high speed centrifugal compressors, incorporating the modification, is running well at full load and that "no problems have been reported regarding any of the respective thrust bearings."

REFERENCES

- Mikula, A. M., 1985, "The Leading Edge Groove Tilting Pad Thrust Bearings: Recent Developments," Transactions of the ASME, *Journal of Tribology*, 107, pp. 423-430.
- Mikula, A. M., 1987, "Further Test Results of the Leading Edge Groove (LEG) Tilting Pad Thrust Bearing," Transactions of the ASME, *Journal of Tribology*, 110, pp. 174-180.
- Mikula, A. M. and Gregory, R. S., 1983, "A Comparison of Tilting-Pad Thrust Bearing Lubricant Supply Methods," Transactions of the ASME, *Journal of Lubrication Technology*, 105, pp. 39-47.

ACKNOWLEDGEMENT

The authors would like to thank all the personnel at Kingsbury, Inc., and Dresser-Rand, Olean, who contributed to the testing of these bearings. The gratitude of the authors is expressed to Kingsbury, Inc., and Dresser-Rand, Olean, for the permission to publish these results.