

# The Effect of Shoe-Backing Material on the Thermal Performance of a Tilting-Pad Thrust Bearing<sup>©</sup>

ANDREW M. MIKULA (Member, STLE)  
Kingsbury, Inc.  
Philadelphia, PA 19154



PREPRINT NO. 88-AM-3D-2  
STLE PREPRINT

*This paper compares various shoe materials and analyzes their influence on the thermal performance of tilting-pad (shoe) equalizing thrust bearings. The paper presents experimental data on 267 mm (10½ inch) O.D. bearings, operating at shaft speeds up to 14 000 RPM with loads ranging up to 4.83 MPa (700 PSI). The data presented demonstrates the effect of shoe construction material on bearing operating babbitt temperature.*

## INTRODUCTION

Tin or lead based (>80 percent) babbitt normally used on the working surface of thrust bearing pads, or "shoes", loses its tensile and compressive strength at elevated temperatures and is subject to creep (1), which places a fundamental limitation on bearing operation. Therefore, babbitt operating temperatures are routinely monitored as an important yet convenient means of assessing bearing risk (2). Providing that a sufficient oil film is developed and maintained, elevated babbitt temperatures are the result of high sliding velocities. The options available to reduce elevated babbitt operating temperatures resulting from the oil film shear rate are limited, and the trade-offs can adversely affect other areas of bearing performance.

Velocity related elevated babbitt temperatures can be reduced either by lowering the heat generated in the oil film or improving the conduction of that heat away from the babbitt by using a backing material with greater thermal conductivity. Pivot location (3), lubricant supply method (1), (4), (5), and lubricant supply temperatures (4) have been shown to be effective in reducing oil film heat generation. The purpose of this paper is to provide the information necessary to evaluate the effect of thermal conduction on

babbitt operating temperature, based upon actual performance data.

The effect of thermal conduction was evaluated on a tilting-pad, equalizing, double thrust bearing arrangement. The tests were conducted with a light turbine oil which had a viscosity of 0.027 Pa·s @ 37.8°C and 0.005 Pa·s @ 98.9°C (150 SSU @ 100°F and 43 SSU @ 210°F—ISO VG 32). The temperature-viscosity curve for this lubricant can be found in Ref. (6). The lubricant supply temperature for all tests was held constant at 46.6°C (115°F). The shaft speed ranged from 4000 RPM to 14 000 RPM, and the load ranged from a "no-load" condition to 4.83 MPa (700 PSI) in increments of 0.345 MPa (50 PSI).

## TEST BEARING DESCRIPTION

The test bearing was a 267 mm (10.5 in) tilting-pad, equalizing, double-thrust bearing. Each thrust bearing consisted of six heavily instrumented pads or shoes on each side of a rotating collar for a (6×6) configuration. The shoes had an O.D. of 267 mm (10.5 in), a bore of 133 mm (5.25 in) for a total bearing area of 356 cm<sup>2</sup> (55.1 in<sup>2</sup>) and were 31.8 mm (1.25 in) thick. Details of this arrangement are shown in Fig. 1.

Lubricant was supplied to the bearings by the conventional pressurized or controlled flow method (7), (8). The oil flow rates supplied to the bearings are shown in Fig. 2 and were determined as described in Ref. (9).

All tests were conducted with the bearing collar shrouded by an oil control ring bored to a 3.97 mm (½ in) radial clearance and fitted with a 25.4 mm (1.0 in) diameter tangential discharge port. Details of this arrangement are shown in Fig. 1. Four bearings were tested under identical conditions of applied load, shaft speed, inlet oil temperature, and oil viscosity. The shoes of each bearing were constructed using a different material. Three bearings had shoes with babbitted (tin based) surfaces, and one bearing had shoes that were not babbitted. Details of the thermal and mechanical properties for each of the four shoe construction materials are as follows:

SHOE CONSTRUCTION MATERIALS			
TEST BRG #	MATERIAL	THERMAL CONDUCTIVITY CAL/CM <sup>2</sup> CM/SEC/°C	TENSILE STRENGTH
1.	Low Carbon Steel	0.124	379.5 MPa (55 KSI)
2.	≈70% CU + Pb + Sn	0.097	165.6 MPa (24 KSI)
3.	Forged ≈98% CU + CR	0.77	365.7 MPa (53 KSI)
4.	Forged ≈99% CU + Ag + Mn + Se	0.93	248.4 MPa (36 KSI)

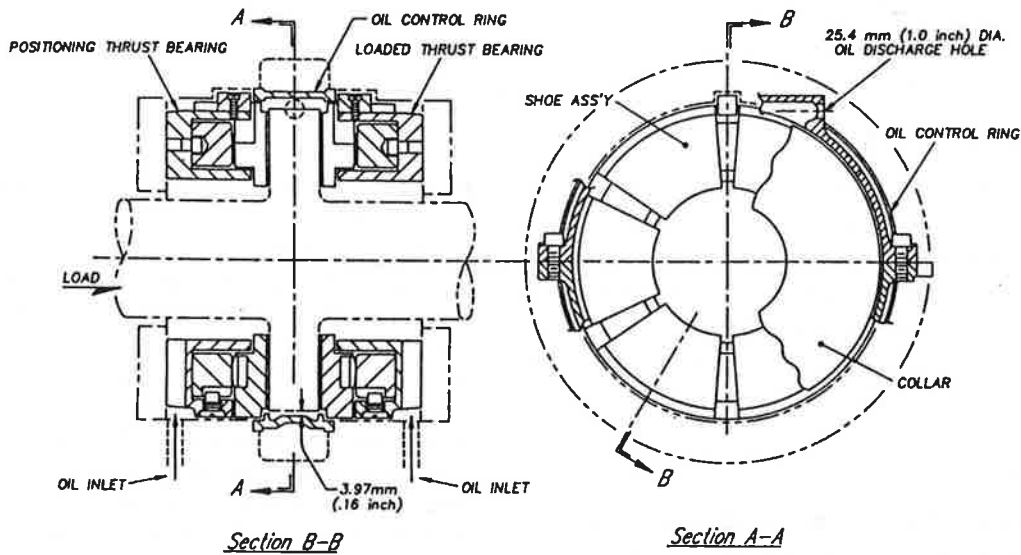

Fig. 1—Double element thrust bearing arrangement with oil control ring configuration

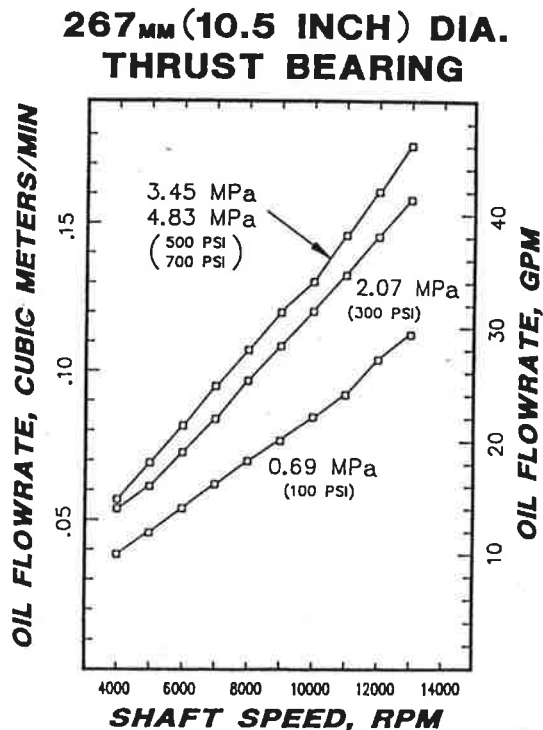

Fig. 2—Oil flow rates supplied to each of the test bearings

Each of the four bearings was instrumented with "J" type (iron-constantan) thermocouples located across the face of the shoes as shown in Fig. 3. Thermocouples were puddled into the babbitt of test bearings Nos. 1, 3 and 4 approximately 0.8 mm ( $\frac{1}{32}$  in) below the surface. Thermocouples were also placed in the lubricant supply and drain lines to measure these temperatures.

Test bearing No. 2 was unique because the working surface was not babbitted. As a consequence, the thermocouples were installed approximately 3 mm (.12 in) below the operating surface.

#### BEARING OPERATING TEMPERATURES

As previously mentioned, bearing operating temperatures are a convenient measure of overall bearing risk. The shoe surface temperature used to evaluate the relative performance of each material was taken at the "75/75 percent" location. Comparisons of the operating babbitt temperatures are made between the maximum measured 75/75 percent temperature of each bearing (the hottest of the six measured 75/75 percent temperature for each bearing). The rationale for the selection of the 75/75 location is explained in Ref. (2), and is generally considered the highest tem-

## THERMOCOUPLE LOCATIONS ON SHOE

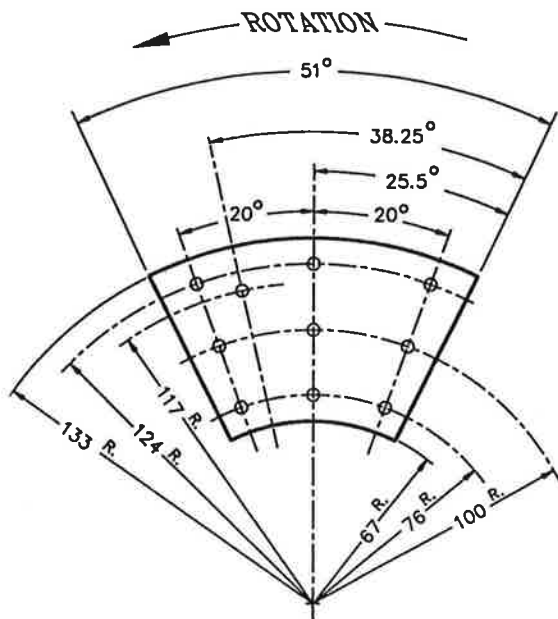

Fig. 3—Thrust shoe thermocouple locations

## 267<sub>MM</sub> (10.5 INCH) DIA. THRUST BEARING

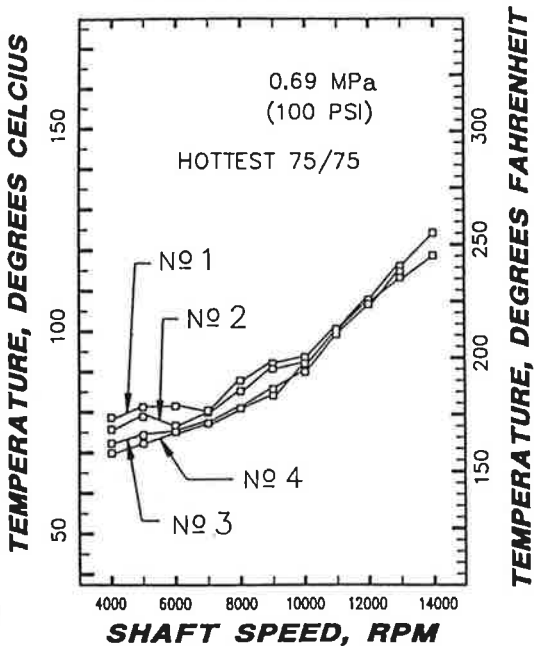

Fig. 4—A comparison of the hottest measured 75/75 percent babbitt temperature locations for each of the four shoe construction materials when loaded to 0.69 MPa at shaft speed of 4000 to 14 000 RPM.

perature and pressure location on a properly designed shoe.

The temperature data shown on Fig. 4 contrasts the hottest recorded 75/75 temperatures reported for each of the four test bearings when operating with an applied load of 0.69 MPa (100 PSI). The relative temperature responses for each of these lightly loaded bearings are segregated into three separate groupings as a function of shaft speed. The first group contains the largest temperature excursions (9°C/

## 267<sub>MM</sub> (10.5 INCH) DIA. THRUST BEARING

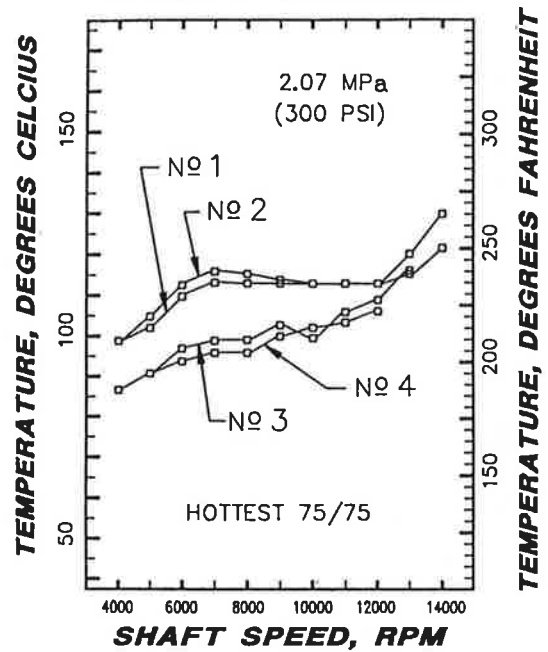

Fig. 5—A comparison of the hottest measured 75/75 percent babbitt temperature locations for each of the four shoe construction materials when loaded to 2.07 MPa at shaft speeds of 4000 to 14 000 RPM.

16°F) which occur between 4000 and 9000 RPM, after which a second group emerges as the responses converge to a minimum (1.7°C/3°F) at 12 000 RPM. The final grouping occurs above 12 000 RPM where the temperature excursions start to diverge.

There are three primary factors that influence the individual operating temperatures for each bearing: oil film shear rate; flow regime in the oil film; and the thermal conductivity of the shoe material. The first grouping seems to be segmented according to the thermal conductivity of the shoe materials. The materials with the greater thermal conductivity reduce the thermal gradient across the shoe, thereby reducing excessive crowning. This results in lower babbitt temperatures and greater load capacity (10), (11). The convergence of the responses in the second grouping seems to be primarily the result of the transition from laminar to turbulent flow in the oil film (2), (6).

The results for a moderate applied load (2.07 MPa/300 PSI) are reported on Fig. 5. At this higher bearing load, the temperature responses once again group themselves according to the thermal conductivity and oil film flow regime. The bearings with the predominantly copper shoes (Nos. 3 and 4) having the greatest thermal conductivity (less crowning) show a decided temperature advantage over the other shoes in the first grouping, reaching a maximum excursion of 15°C (25°F) at 7000 RPM. This advantage starts to dissipate above 7000 RPM as the temperatures start to converge in the second group. This convergence occurs because bearings 1, 2, 3 and 4 appear to be operating at different oil film flow conditions.

The temperature responses to a still higher bearing load (3.45 MPa/500 PSI) are depicted in Fig. 6. Once again, the temperatures formed two groups based on their respective

**267<sub>MM</sub> (10.5 INCH) DIA.  
THRUST BEARING**

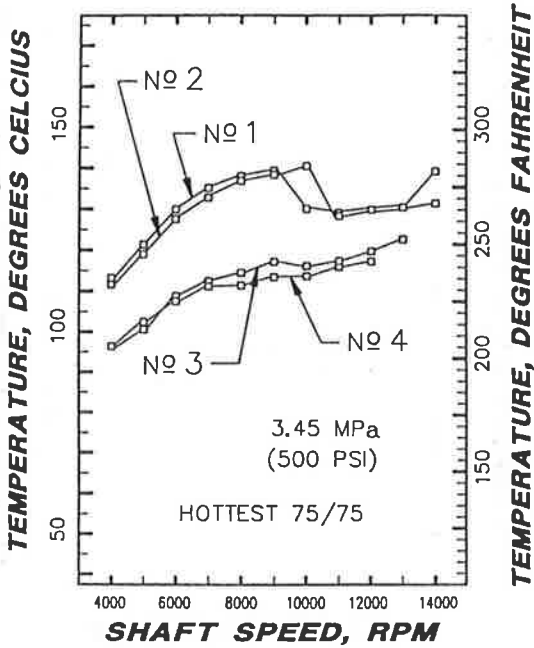

Fig. 6—A comparison of the hottest measured 75/75 percent babbitt temperature locations for each of the four shoe construction materials when loaded to 3.45 MPa at shaft speeds of 4000 to 14 000 RPM.

**267<sub>MM</sub> (10.5 INCH) DIA.  
THRUST BEARING**

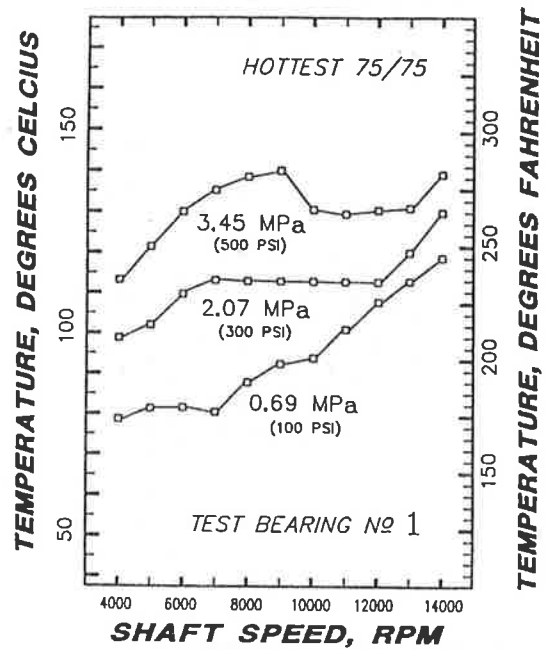

Fig. 8—A comparison of the hottest measured 75/75 percent babbitt temperature locations for test bearing No. 1 (steel) when loaded with three tested loads at shaft speeds of 4000 to 13 000 RPM.

**267<sub>MM</sub> (10.5 INCH) DIA.  
THRUST BEARING**

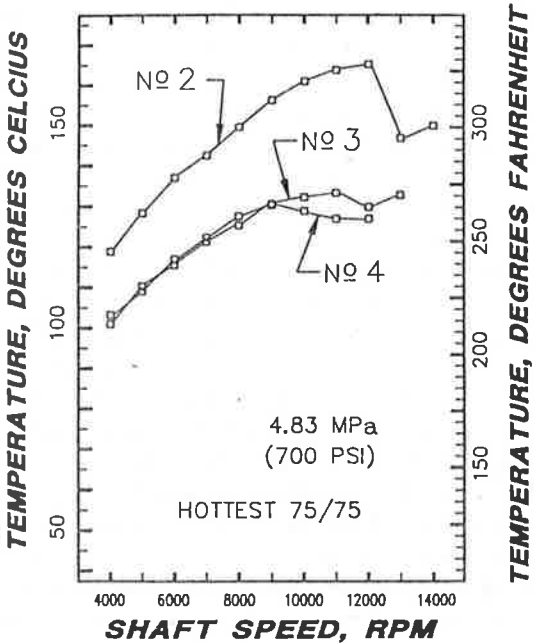

Fig. 7—A comparison of the hottest measured 75/75 percent babbitt temperature locations for each of the four shoe construction materials when loaded to 4.83 MPa at shaft speeds of 4000 to 14 000 RPM.

thermal conductivities and flow regime. The predominantly copper shoes, with their greater ability to conduct the heat from the operating surface, reported significantly lower temperatures. This advantage reached 22°C (40°F) at a shaft speed of 8000 RPM, after which the two groups started to once again converge. Even more evident at this high unit

loading are the turbulent transition points for bearings 1 and 2.

The temperature responses for the highest load tested (4.83 MPa/700 PSI) are shown on Fig. 7. One result of the increased load is immediately obvious—the elimination of bearing No. 1 (steel) due to excessive crowning and high babbitt temperatures. The three remaining bearings performed as they had previously. The bearings with predominantly copper shoes operated significantly cooler (35°C/65°F @ 12 000 RPM). The lowest recorded operating surface temperatures once again being reported from the bearings with the highest thermal conductivity shoe materials. It should be noted that the ability of test bearing No. 2 to survive the high operating temperatures (167°C/331°F) is attributable to the lack of a babbitted operating surface.

The individual responses for each of the bearings are grouped in Figs. 8 to 11. These groupings isolate, for each bearing, the load-temperature relationship as a function of shaft speed. Comparing the overall performance of each bearing, some similarities can be noted. The temperature excursions from lowest to highest load reach a maximum at 9000 to 10 000 RPM, and a minimum at the maximum shaft speed. This reduction in the temperature excursions occurs as a result of the transition from laminar to turbulent oil film flow evident at 9000 to 10 000 RPM.

**CONCLUSIONS**

High thermal conductivity shoe materials are effective in lowering bearing operating temperatures because they conduct the heat away from the working surface and are not subject to excessive thermal crowning.

The mechanical properties of the shoe materials does not

**267<sub>MM</sub> (10.5 INCH) DIA.  
THRUST BEARING**

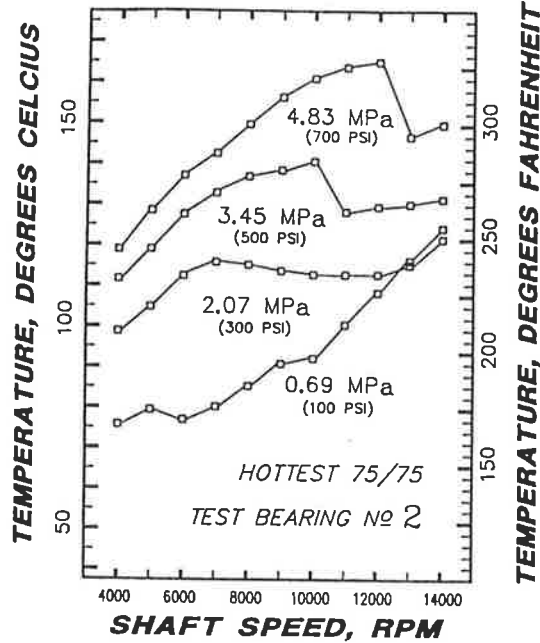

Fig. 9—A comparison of the hottest measured 75/75 percent babblitt temperature locations for test bearing No. 2 (70 percent CU + Pb + Sn) when loaded with four tested loads at shaft speeds of 4000 to 14 000 RPM.

**267<sub>MM</sub> (10.5 INCH) DIA.  
THRUST BEARING**

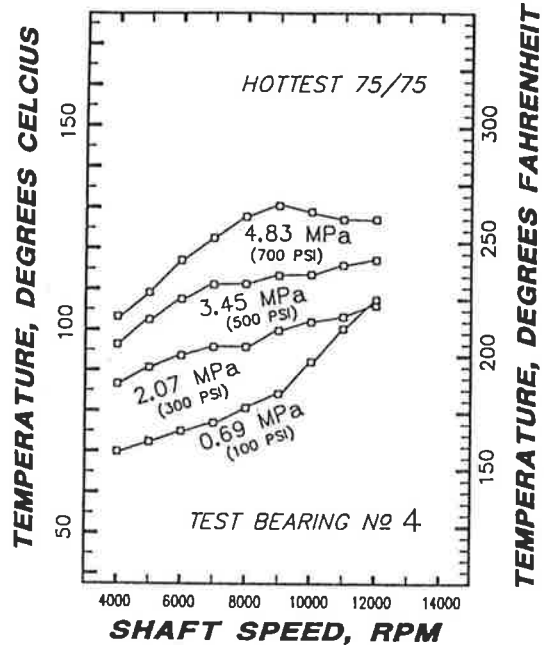

Fig. 11—A comparison of the hottest measured 75/75 percent babblitt temperature locations for test bearing No. 4 (99 percent CU + Ag + Mn + Se) when loaded with four tested loads at shaft speeds of 4000 to 12 000 RPM.

**267<sub>MM</sub> (10.5 INCH) DIA.  
THRUST BEARING**

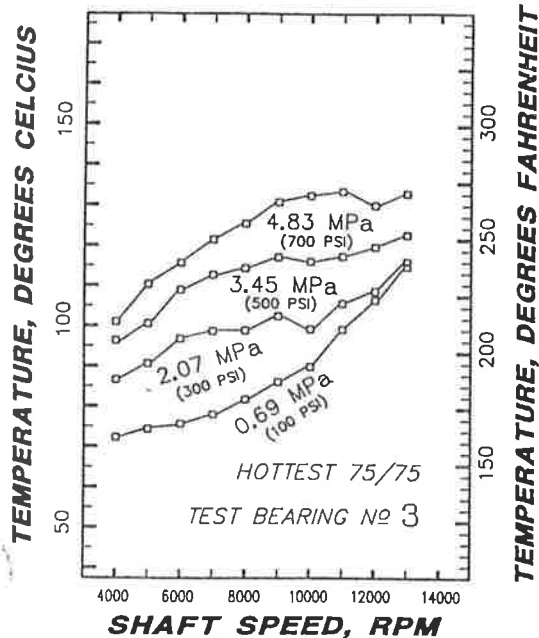

Fig. 10—A comparison of the hottest measured 75/75 percent babblitt temperature locations for test bearing No. 3 (93 percent CU + CR) when loaded with four tested loads at shaft speeds of 4000 to 13 000 RPM.

seem to have a significant effect on bearing operating temperatures for these loads, shoe size and thickness, and pivot support conditions. Larger bearings could be affected where shoe supports allow mechanical deflections. The turbulent regime reduces bearing operating temperatures.

**ACKNOWLEDGMENT**

The facilities and personnel of Kingsbury, Inc. were utilized to perform these bearing tests, collect and process the data included in this paper, and prepare this manuscript for presentation. The gratitude of the author is expressed to Kingsbury, Inc. for the opportunity to publish these results.

**REFERENCES**

- (1) Mikula, A. M. and Gregory, R. S., "A Comparison of Tilting-Pad Thrust Bearing Lubricant Supply Methods," *ASME Jour. of Lub. Tech.*, **105**, 1, pp 39-47, (1983).
- (2) Mikula, A. M., "Evaluating Tilting-Pad Thrust Bearing Operating Temperatures," *ASLE Trans.*, **29**, 2, pp 173-178 (1986).
- (3) Gardner, W. W., "Performance Tests on Six-Inch Tilting-Pad Thrust Bearings," ASME Paper No. 74-Lub-13.
- (4) Mikula, A. M., "The Leading-Edge-Groove Tilting-Pad Thrust Bearing: Recent Developments," *ASME Jour. of Trib.*, **107**, pp 423-430, (1985).
- (5) Mikula, A. M., "Further Test Results of the Leading-Edge-Groove (LEG) Tilting-Pad Thrust Bearing," ASME Paper No. 87-Trib-26.
- (6) Mikula, A. M., "The Effect of Lubricant Supply Temperature on Thrust Bearing Performance," *ASLE Trans.*, **30**, 2, pp 220-224 (1987).
- (7) Gregory, R. S., "Performance of Thrust Bearings at High Operating Speeds," *ASME J. of Lubr. Tech.*, **96**, 1, pp 7-14 (1974).
- (8) Gregory, R. S., "Operating Characteristics of a Fluid-Film Thrust Bearing Subject to High Shaft Speeds," Super Laminar Flow in Bearings, Mech. Eng. Publications, Ltd., Suffolk, England (1977).
- (9) Gregory, R. S., "Factors Influencing Power Loss of Tilting-Pad Thrust Bearings," *ASME J. of Lubr. Tech.*, **101**, 2, pp 154-163 (1979).
- (10) Boyd, S. and Raimondi, A. A., "Influence of Surface Profile on the Load Capacity of Thrust Bearings with Centrally Pivoted Pads," *ASME Trans.*, **77**, pp 321-330 (1955).
- (11) Chambers, W. S. and Mikula, A. M., "Operational Data for a Large Vertical Thrust Bearing in a Pumped Storage Application," ASLE Preprint No. 87-AM-7F-1.